



























































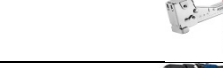

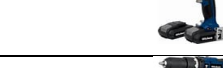

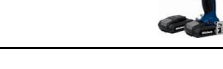

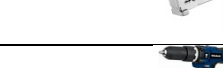

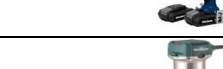

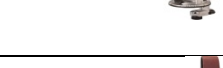
Document technique de fabrication

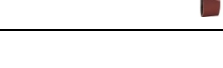
Feuille de débit

Code couleurs	Nomenclature	dimension en mm			quantité Pour	
		Epaisseur	Largeur	Longueur	Une unité	Six unités
	Cotés A	40	180	3020	2	12
	Cotés B	40	200	3100	2	12
	Cotés C	40	200	3020	2	12
	Cotés D	40	180	1100	2	12
	Cotés E	40	200	1100	2	12
	Cotés F	40	200	1020	2	12
	Baguette de fixation toile de paillage	20	40	9 ml	1	18 ml
	Séparation intermédiaire haute	40	180	1020	1	6
	Séparation intermédiaire	40	200	1020	2	12
	Renfort de fixation intermédiaire	40	80	580	4	24
	Renfort de fixation angle	80	80	580	4	24
	Toile de paillage		0.60 ml	12 ml	1	6 = 72 ml
	vis à bois fixation planches des cotés		6 x 80		170	1020
	vis à bois fixation baguette toile de paillage		4 x 60		60	360
	Agrafe toile de paillage				100	600
	Disque ponceuse				2	12
	Bande ponceuse				1	6

Liste des opérations

Opération	Document		actions	Outils	EPI
Réception matériau	Bon de commande		Vérification Stockage		
Débit de longueur	Feuille de débit		Découper de longueur tous les éléments en bois		
Fabrication baguette de fixation toile de paillage			Déclignage les baguettes de fixation de la toile de paillage		
Découpe toile de paillage	Détail de fabrication		Découper la toile de paillage		
Fabrication Renfort de fixation inter			Décligner Renfort de fixation inter		
Préparation montage	croquis de fabrication		Tracer le perçage des cotés		
			Perçage pour fixation des cotés		
	Détail de fabrication		Tracer le perçage des baguettes de fixation de la toile de paillage		
			Perçage des baguettes de fixation de la toile de paillage		
			Tracer le perçage des Renfort de fixation d'angle et intermédiaires		
			Perçage des Renfort de fixation d'angle et intermédiaires		
Montage	Liste des Opérations		Assemblage des cotés		
			Agrafages toile de paillage face intérieure des cotés		
			fixation des Renfort de d'angle et intermédiaires		
	Détail de fabrication		Pose Séparation intermédiaire		
			Agrafages toile de paillage Séparation intermédiaire		
			Pose baguettes de fixation de la toile de paillage		
			Arrondir les angles périphériques et des renforts inter et d'angles		
Finition		Ponçage mécanique			
		Ponçage manuel			
Livraison					
			Vérification générale des bacs par le client		

Croquis de fabrication

Vue d'ensemble

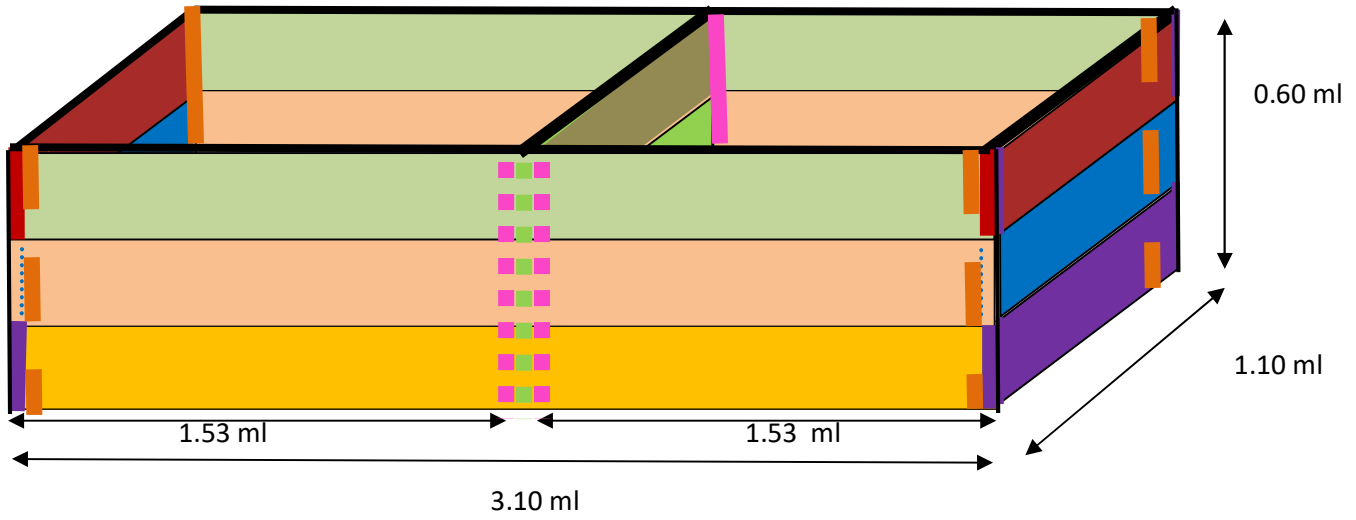

Vue de dessus

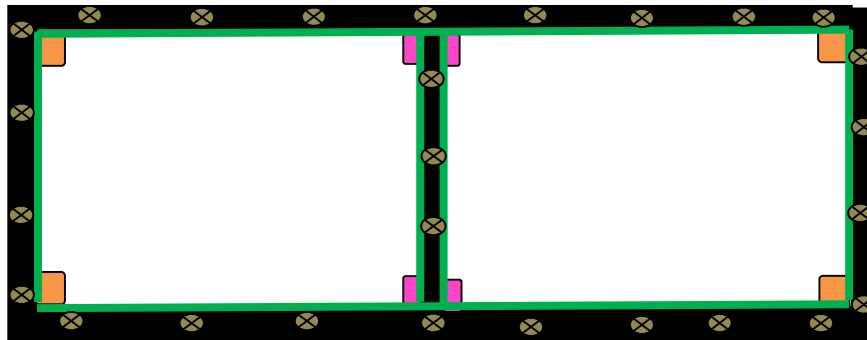

Vue de coté

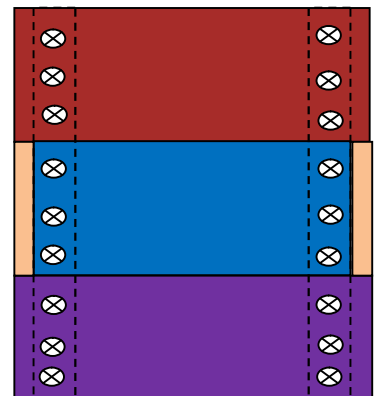

Vue de face

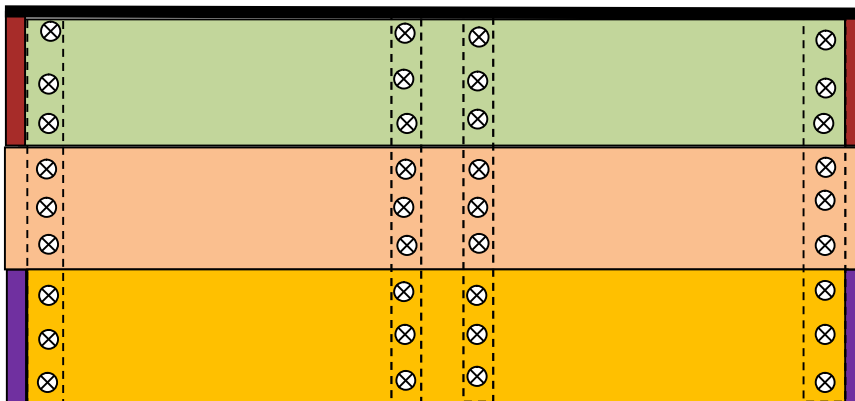

Détail de fabrication

Délimitation Baguette de fixation toile de paillage coté A

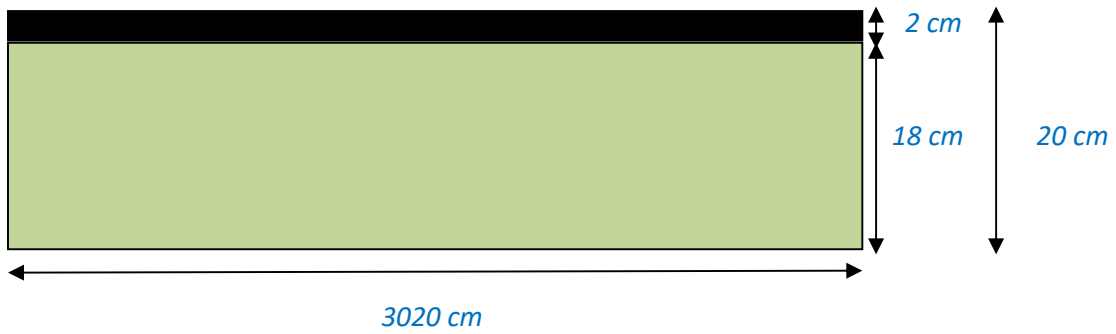

Délimitation Baguette de fixation toile de paillage coté D

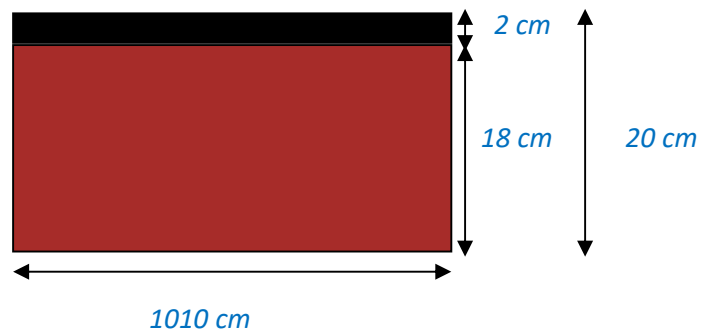

Délimitation Baguette de fixation toile séparation intermédiaire Haute

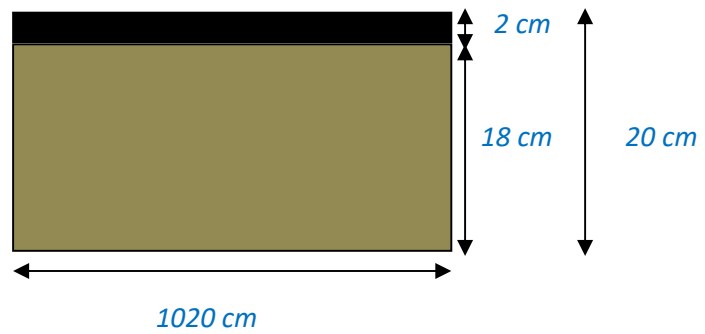

Délimitation renfort de fixation toile séparation intermédiaire

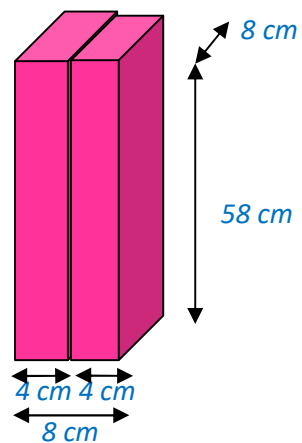

Perçage coté A

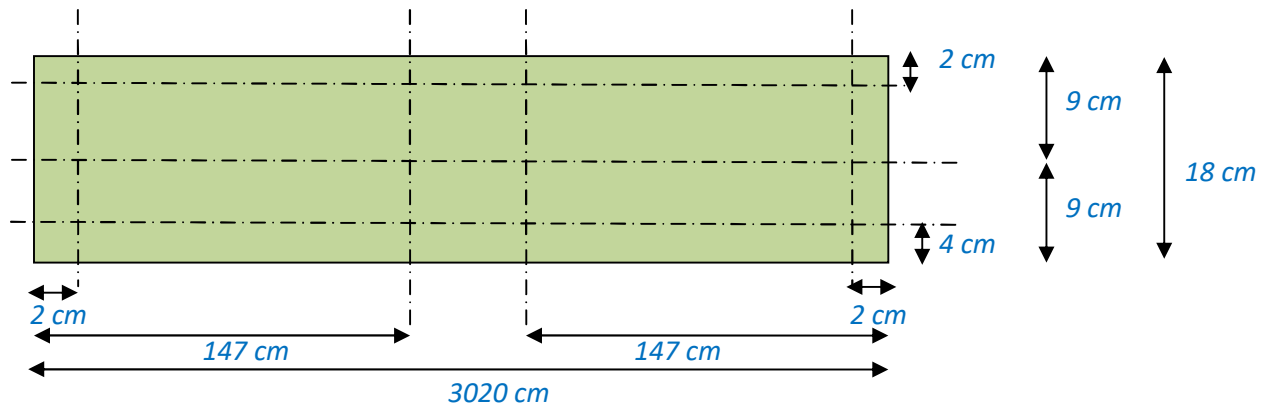

Perçage coté B

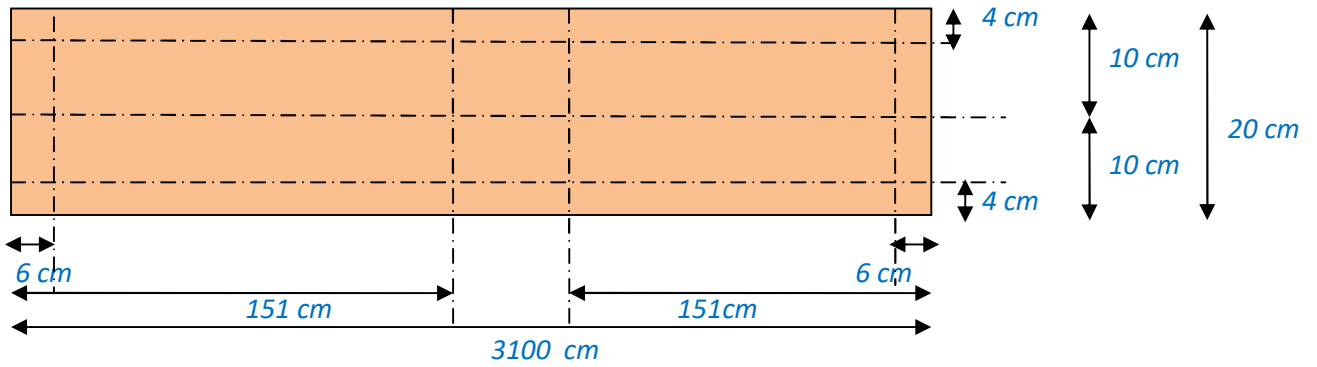

Perçage coté C

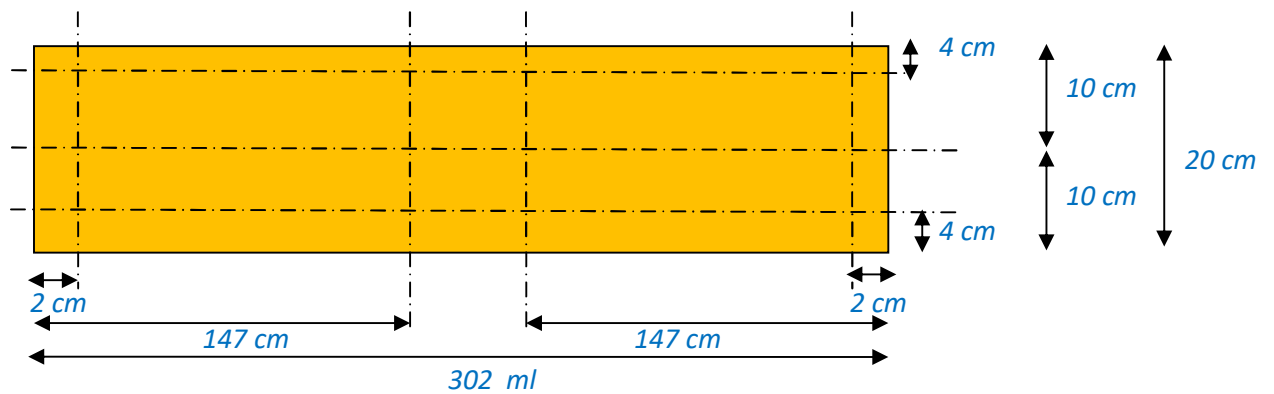

Perçage coté D

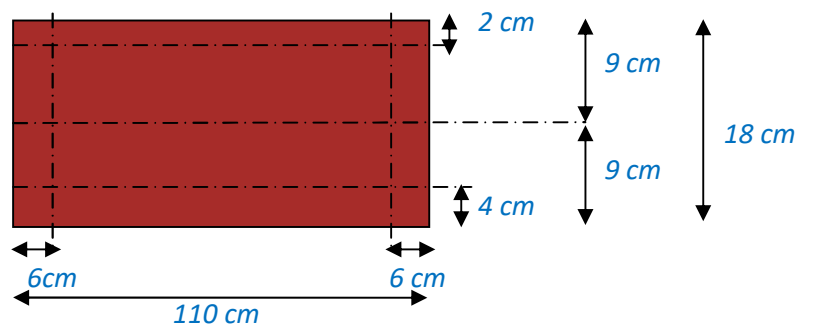

Perçage coté E

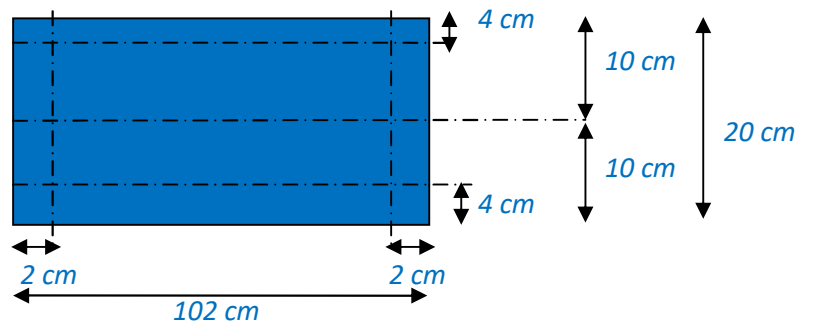

Perçage coté F

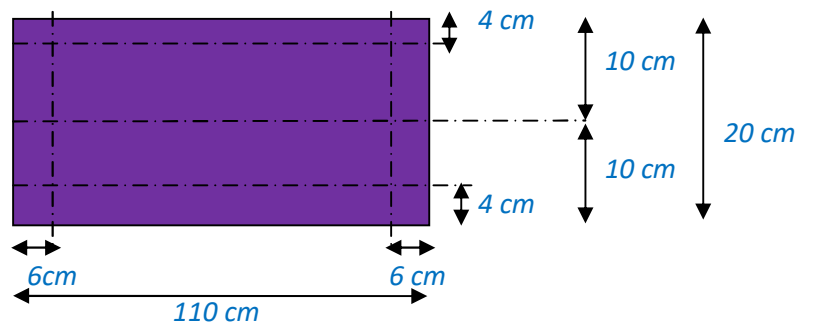

Finition baguette de fixation toile de paillage

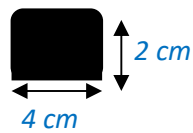

Perçage fixation toile de paillage

